

Illust is DPC-797.

\* Refer to parts list on page 12.

## SPECIFICATIONS

### Format

System ..... Compact disc digital audio system  
 Laser ..... Semiconductor laser

### Audio

Frequency response ..... 20 Hz to 20 kHz,  $\pm 3$  dB  
 PHONES output level (16 $\Omega$ , 1 kHz) ..... 8 mW + 8 mW  
 Line output/impedance ..... 0.55 Vrms/1 k $\Omega$

### Power supply

External DC supply ..... 4.5V to 6 V DC  
 Rechargeable batteries (NB-88/NB-130) x 2 or 4 ..... DC 2.4 V  
 Commercially-available alkaline batteries (LR6/AA) x 2 or 4 ..... DC 3 V

### Battery life (continuous repeat playback)

(Figures inside parentheses show the performance when the D.A.S.C. is ST or HI.)

Commercially-available alkaline batteries (LR6/AA) x 2 ..... Approx. 16 (12) Hours  
 Commercially-available alkaline batteries (LR6/AA) x 4 ..... Approx. 35 (30) Hours  
 Rechargeable batteries (NB-88) x 2 ..... Approx. 6.5 (4.5) Hours  
 Rechargeable batteries (NB-130) x 2 ..... Approx. 8 (5.5) Hours  
 Batteries (LR6/AA) x 2 and (NB-88) x 2 ..... Approx. 22.5 (16.5) Hours  
 Batteries (LR6/AA) x 2 and (NB-130) x 2 ..... Approx. 24 (17.5) Hours

Dimensions (W x H x D) ..... 132 mm x 30 mm x 138 mm  
 Weight (net) ..... 245 g

### Note:

KENWOOD follows a policy of continuous advancements in development. For this reason specifications may be changed without notice.

In compliance with Federal Regulations, following are reproductions of labels on, or inside the product relating to laser product safety.

KENWOOD-Corp. certifies this equipment conforms to DHHS Regulations No. 21 CFR 1040. 10, Chapter 1, Subchapter J.

**DANGER : Laser radiation when open and interlock defeated.  
 AVOID DIRECT EXPOSURE TO BEAM.**

# DPC-397/797/997

## CONTENTS / ACCESSORIES

### Contents

SPECIFICATIONS .....	Top cover	SCHMATIC DIAGRAM .....	7
CONTENTS / ACCESSORIES .....	2	EXPLODED VIEW .....	11
DISASSEMBLY FOR REPAIR.....	3	PARTS LIST.....	12
PC BOARD .....	4		

Note: Please refer to DPC-193 service manual(B51-5451-00) if need the information of microprocessor.

### Model feature list

MODEL	3					7					9		
	DPC-397					DPC-797					DPC-997		
DESTINATION	P	M	M2	X	E	P	M	M2	T	E	X	T	E
ABBRIB.	P3	M3	M4	X3	E3	P7	M7	M8	T7	E7	X9	T9	E9
DASC<OFF-ON(4M)>IC7	YES	YES	YES	YES	YES	-	-	-	-	-	-	-	-
DASC<ON-OFF(16M)>IC6	-	-	-	-	-	YES	YES	YES	YES	YES	YES	YES	YES
DIGITAL OPT OUT(J104)	YES	YES	YES	-	YES	YES	YES	YES	YES	YES	-	YES	YES
LINE OUT(J105)	-	-	-	YES	-	-	-	-	-	-	YES	-	-
REMOCON JACK(J103)	YES	YES	YES	YES	YES	YES	YES	YES	YES	YES	YES	YES	YES
CAR BATTERY ADP.	-	-	-	-	-	YES	-	-	-	-	-	-	-
CAR CASSETTE ADP.	-	-	-	-	-	YES	-	-	-	-	-	-	-
AC PLUG ADAPTER	-	YES	YES	-	-	-	YES	YES	-	-	-	-	-
RECHARGEABLE BATT.	NB-88	NB-88	NB-88	NB-88	NB-88	-	NB-88	NB-130	NB-88	NB-88	NB-130	NB-130	NB-130
INNER HEADPHONE(SHORT)	YES	YES	YES	YES	YES	-	YES	YES	YES	YES	-	-	-
INNER HEADPHONE(LONG)	-	-	-	-	-	YES	-	-	-	-	-	-	-
NOISE CANCEL HP(SHORT)	-	-	-	-	-	-	-	-	-	-	YES	YES	YES
REMOCON WIRED*	3 KEY	LCD	LCD*	LCD	3 KEY	-	LCD*	LCD*	LCD	LCD	LCD*	LCD*	LCD*

LCD\*:LCD WITH BACK LIGHT

### Accessories

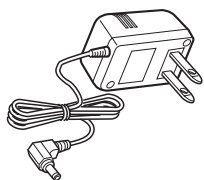
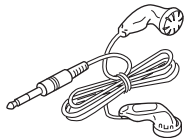
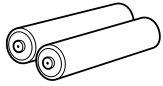
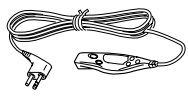
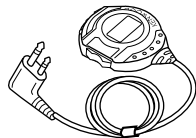
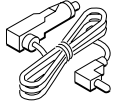
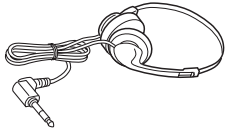
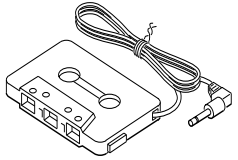
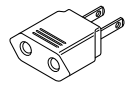
<p>AC adapter.....(1)                  (W08-0677-08) : P7P3                  (W08-0658-08) : E9E7E3                  (W08-0678-08) : T9T7                  (W08-0679-08) : X9X3                  (W08-0675-05) : M3M4M7</p> 	<p>Innerphone.....(1)                  (W01-0925-05) : P7                  (W01-0923-05) : E3X3P3E7M7T7M3M4</p> 	<p>Rechargeable battery.....(1)                  (W09-1237-05)NB-130 : X9T9E9                  (W09-1239-05)NB-88 : P3                  (W09-1240-05)NB-88 : E3E7M3M4M7T7X3</p> 
<p>Remote control.....(1)                  (A70-1111-08) : P3E3</p> 	<p>Remote control.....(1)                  (A70-1190-05) : E7T7M3X3                  (A70-1171-05) : M4T9X9E9M7</p> 	<p>Car battery adapter.....(1)                  (W03-5853-08) : P7</p> 
<p>Headphone.....(1)                  (W01-0946-05) : E9T9X9</p> 	<p>Car cassette adapter.....(1)                  (W01-0922-05) : P7</p> 	<p>AC plug.....(1)                  (E03-0115-05) : M3M4M7</p> 

Note : This system uses a microcomputer so it may malfunction due to external noise or interference.  
 In such a case, unplug the power cord and remove the batteries, then re-connect the power cord and insert the batteries again.

# DPC-397/797/997

## DISASSEMBLY FOR REPAIR

### (Remove the CD door and the top cabinet)

1. Remove the 5 screws (①) on the bottom.
2. Open the battery cover, then remove the 2 screws (②).
3. Push the left side of the top cabinet (③), then remove it from the hook on the battery case (④).

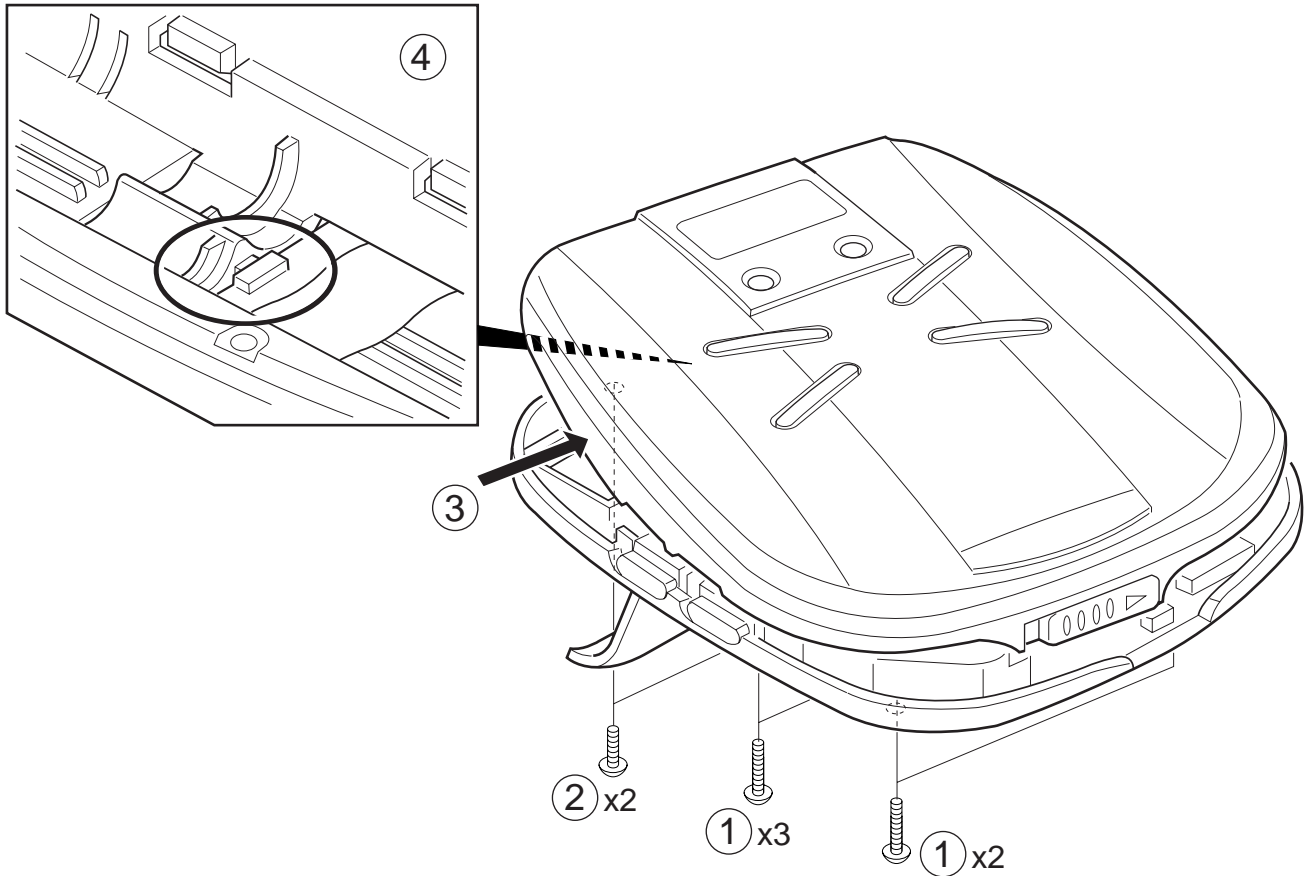

# PC BOARD

## (Component side view)

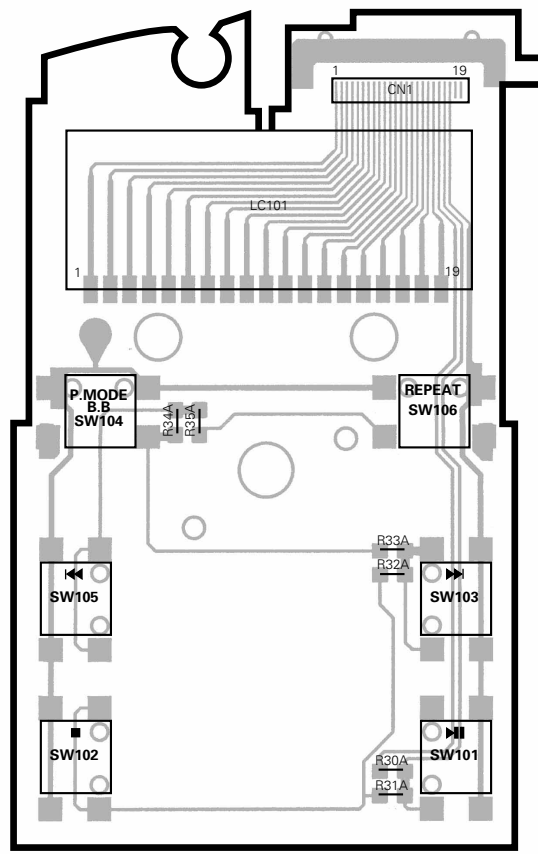

## (Foil side view)

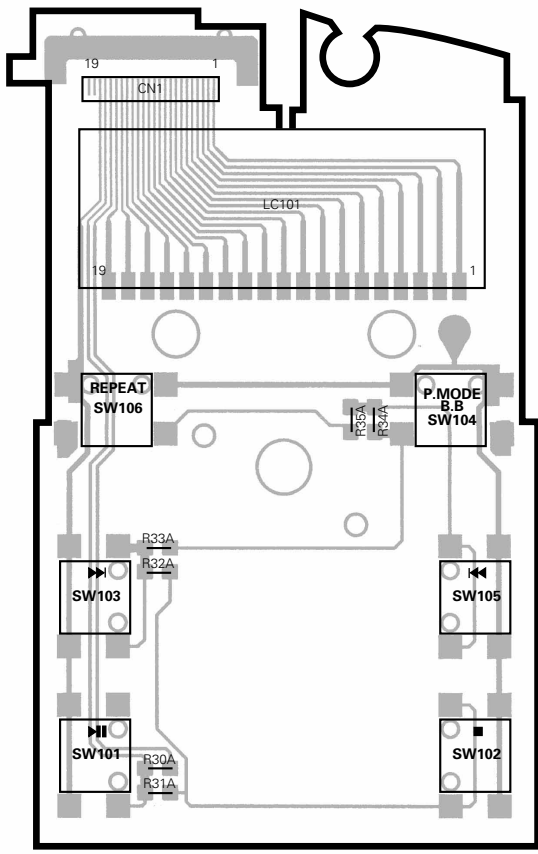

# PC BOARD (Component side view)

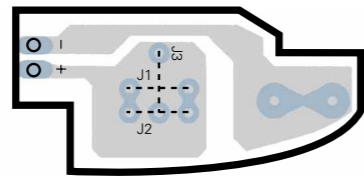
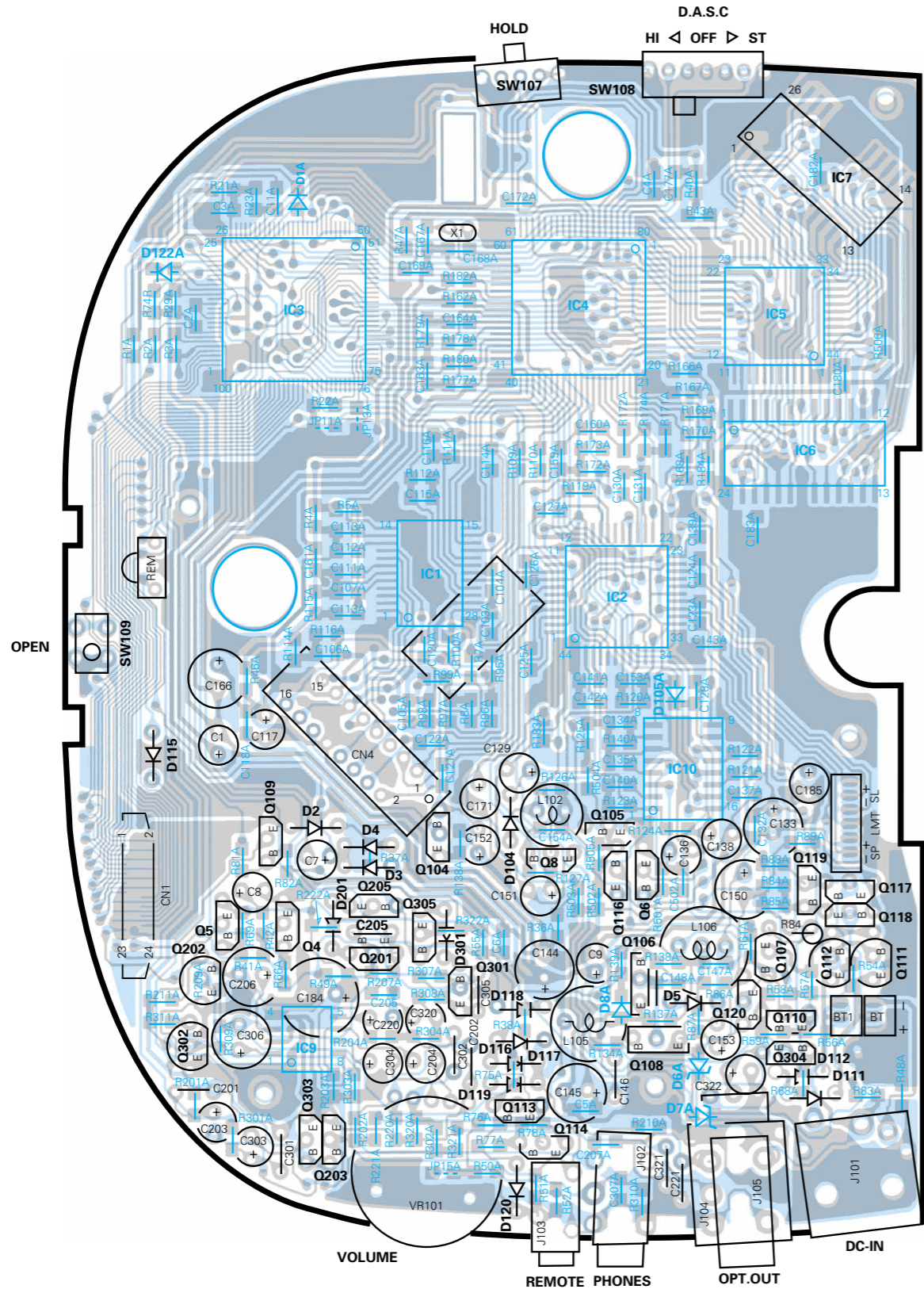

# (Foil side view)

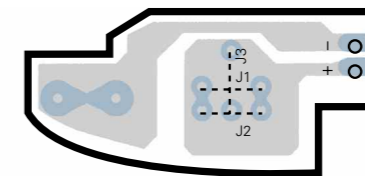
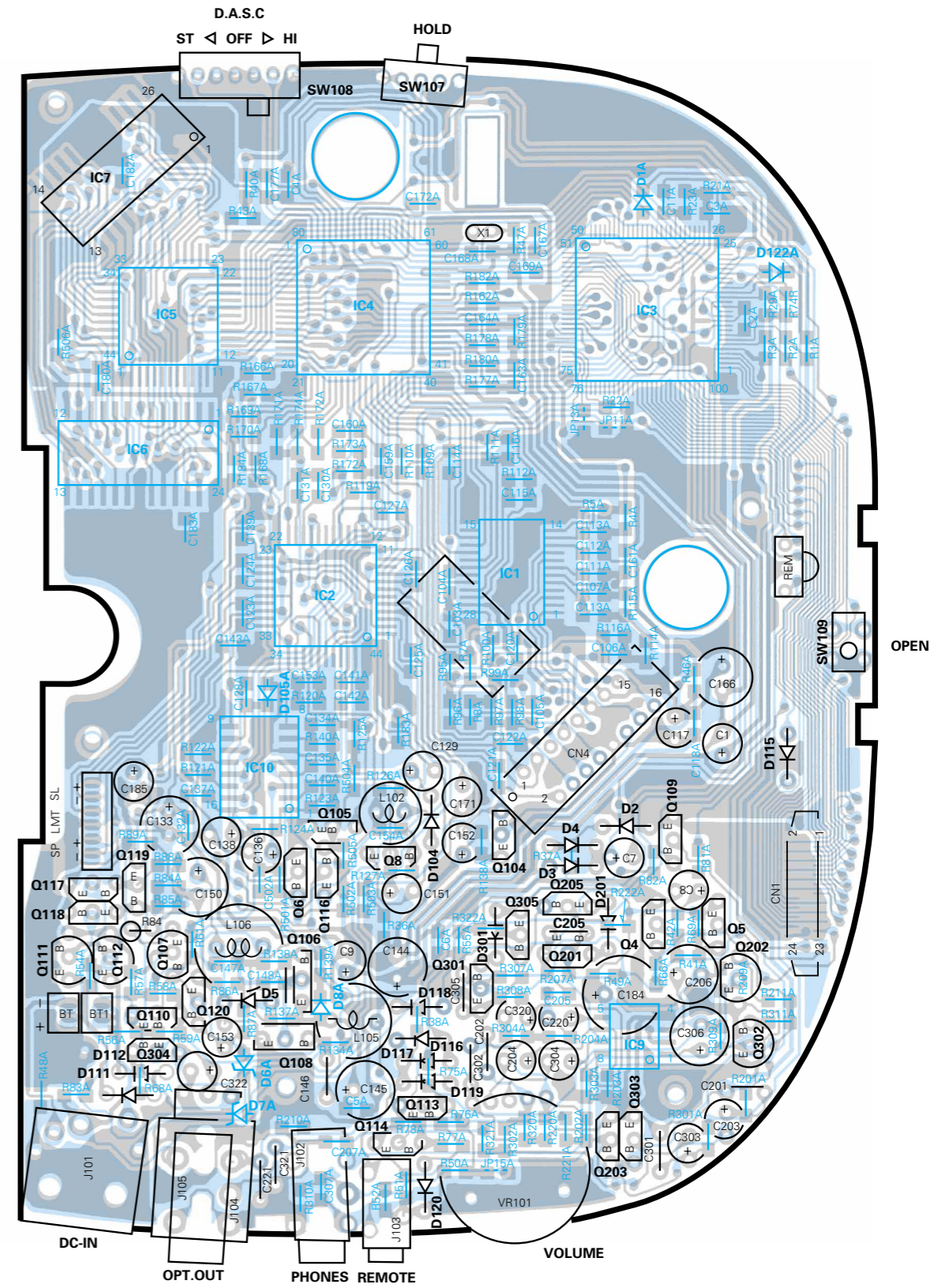

Refer to the schematic diagram for the value of resistors and capacitors.

MECHA. ASS'Y  
(KSM-620AAA)

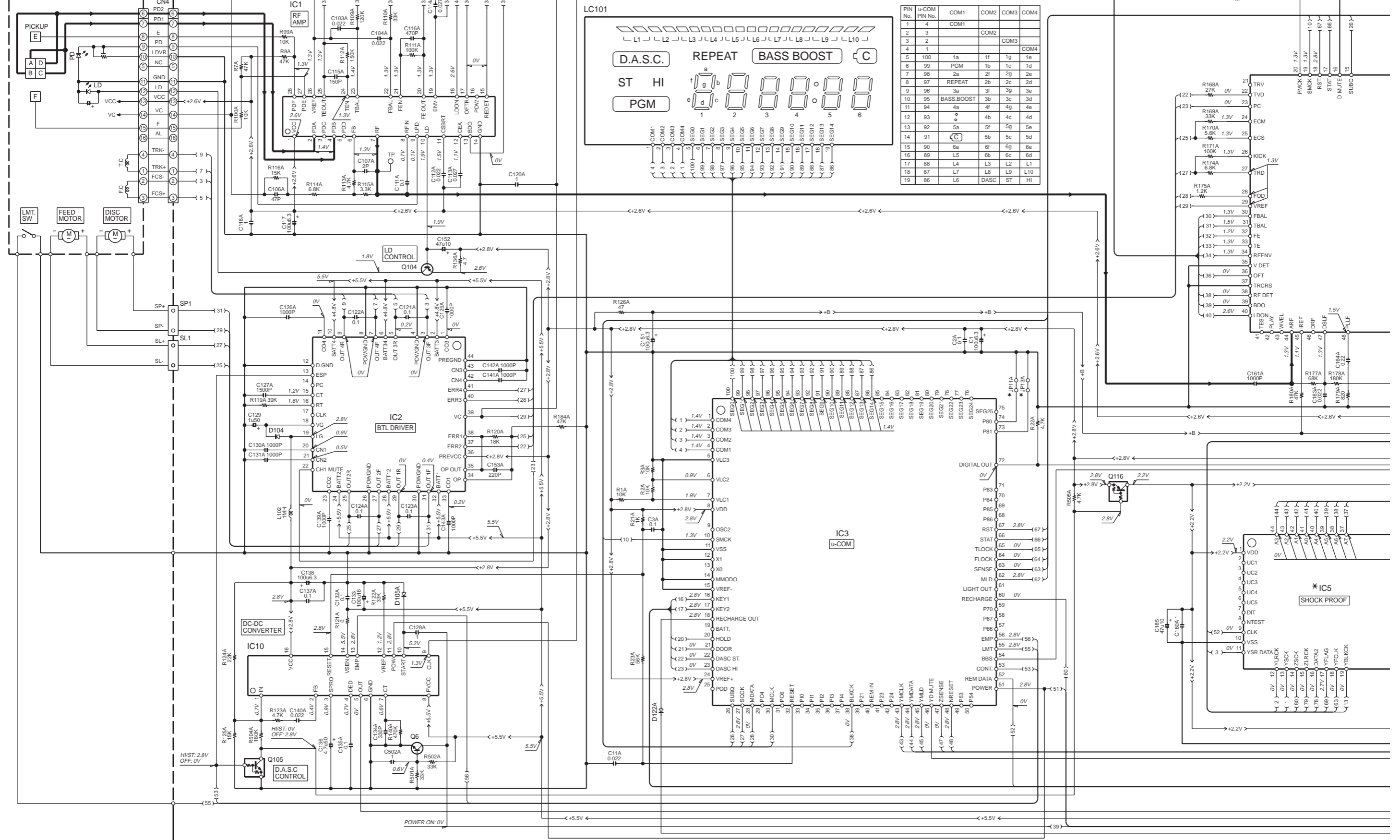

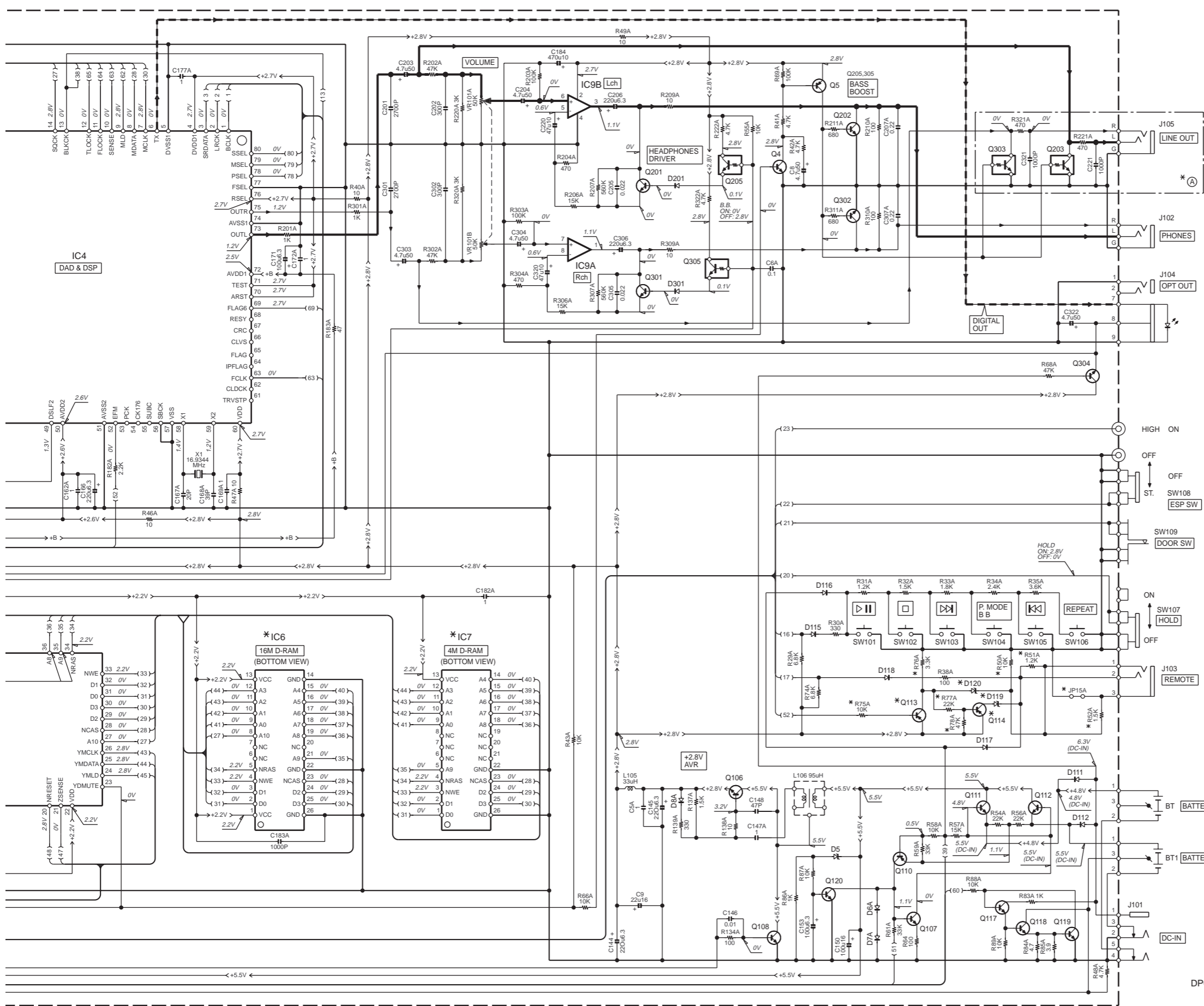

DPC-997

DESTINATION	COUNTRY	ABB.	A	IC5	IC6	IC7	Q113	Q114	D119, 120	R50A, 75A-78A	R51A, 52A	JP11A, 13A, 15A
AUSTRALIA	X9	YES					NO	NO	NO	NO	NO	NO
U.K.	T9	NO	SM5902AF	YES	NO	YES	YES	YES	YES	YES	NO	YES
EUROPE	E9	NO					NO	NO	NO	NO	NO	NO

DPC-397

DESTINATION	COUNTRY	ABB.	A	IC5	IC6	IC7	Q113	Q114	D119, 120	R50A, 77A, 78A	R51A, 52A	R75A	JP11A, 13A	JP15A
AUSTRALIA	X3	YES					NO	NO	NO	NO	NO	NO	NO	NO
CANADA	P3	NO	SM5859AF	NO	YES	YES	NO	NO	NO	NO	NO	NO	NO	NO
EUROPE	E3	NO					NO	NO	NO	NO	NO	NO	NO	NO
GENERAL MARKET	M4	NO					YES	YES	YES	YES	NO	YES	NO	YES

DPC-797

DESTINATION	COUNTRY	ABB.	A	IC5	IC6	IC7	Q113	Q114	D119, 120	R50A, 77A, 78A	R51A, 52A	R75A, 76A	JP11A, 13A, 15A
CANADA	M7	NO					YES	YES	YES	YES	NO	YES	YES
U.K.	T7	NO	SM5902AF	YES	NO	YES	NO	NO	NO	NO	NO	YES	YES
EUROPE	E7	NO					NO	NO	NO	NO	NO	NO	NO

- IC1 : AN8838SB
- IC2 : BH6509K
- IC3 : MN101C167
- IC4 : MN662746RPK1
- IC5 : \*
- IC6 : MN41V17400CTT6
- IC7 : MN41V4400SJ-08
- IC9 : NJM2073M
- IC10 : AN8086S

- Q4,6,117-120,201,301,304 : 2SC3330
- Q5,104,110,113,114 : 2SA1317
- Q105 : 2SC4048-AC
- Q106 : 2SC4481T
- Q107,202,302 : 2SD734F
- Q108 : 2SD1805F
- Q111,112 : 2SB926T
- Q116 : 2SA1564-AC
- Q203,205,303,305 : 2SC3860
- D5 : UDZ6.8B
- D104,119,120 : SB10-03A3-BT
- D115-118,201,301 : GMB01-BT
- D111,112 : IN4001
- D6A-8A,105A,122A : 1SS355

SM5902AF

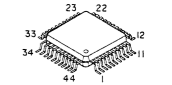

NJM2073M

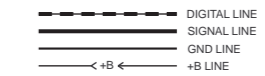
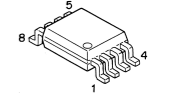

**CAUTION:** For continued safety, replace safety critical components only with manufacturer's recommended parts (refer to parts list).  $\Delta$  indicates safety critical components. For continued protection against risk of fire, replace only with same type and rating fuse(s). To reduce the risk of electric shock, leakage-current or resistance measurements shall be carried out (exposed parts are acceptably insulated from the supply circuit) before the appliance is returned to the customer.

The DC voltage is an actual reading measured with a high impedance type voltmeter. The measurement value may vary depending on the measuring instruments used or on the product. Refer to the voltage during PLAY with DASC OFF (at the normal speed) unless otherwise specified; The value shown in ( ) is the voltage measured at the moment of STOP.

DPC-997/DPC-397/DPC-797(K)

# DPC-397/797/997

Y22-7910-11

KENWOOD

# DPC-397/797/997

## EXPLODED VIEW(UNIT)

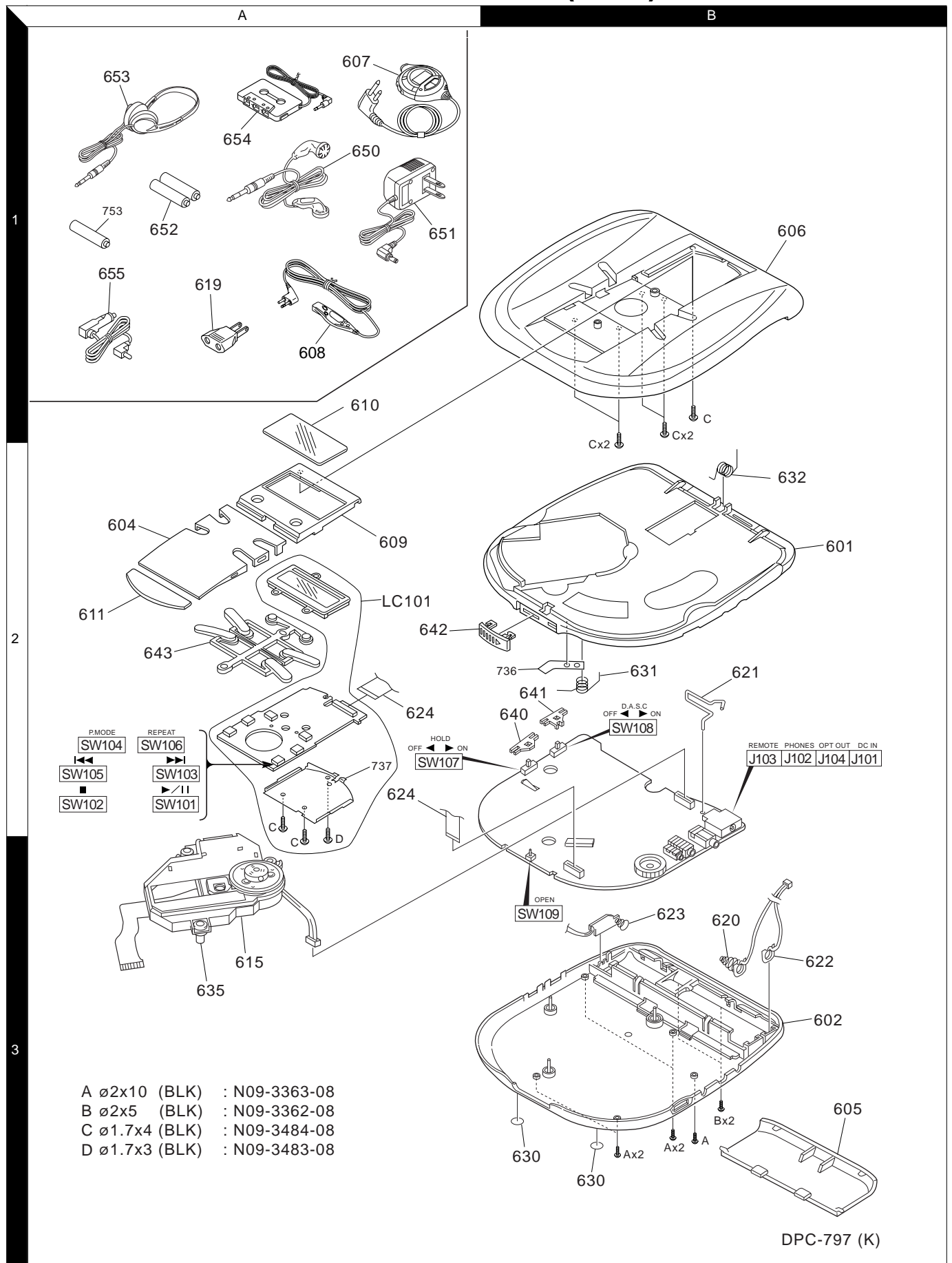

- A  $\varnothing 2 \times 10$  (BLK) : N09-3363-08
- B  $\varnothing 2 \times 5$  (BLK) : N09-3362-08
- C  $\varnothing 1.7 \times 4$  (BLK) : N09-3484-08
- D  $\varnothing 1.7 \times 3$  (BLK) : N09-3483-08

DPC-797 (K)



\* New Parts

Parts without **Parts No.** are not supplied.Les articles non mentionnés dans le **Parts No.** ne sont pas fournis.Teile ohne **Parts No.** werden nicht geliefert.

①

Ref. No	Add-ress	New Parts	Parts No.	Description	Desti-nation	Re-marks
<b>DPC-397/797/997</b>						
601	2B	*	A02-2883-08	TOP CABINET 103-03971-071	E3X3	
601	2B	*	A02-2883-08	TOP CABINET 103-03971-071	M4M3P3	
601	2B	*	A02-2884-08	TOP CABINET 103-03972-047	E7E9T9	
601	2B	*	A02-2884-08	TOP CABINET 103-03972-047	M7	
601	2B	*	A02-2887-08	TOP CABINET 103-03973-047	X9P7T7	
602	3B	*	A02-2885-08	BOTTOM CABINET 104-03971-071	E3X3	
602	3B	*	A02-2885-08	BOTTOM CABINET 104-03971-071	M4M3P3	
602	3B	*	A02-2886-08	BOTTOM CABINET 104-03971-078	E7E9T9	
602	3B	*	A02-2886-08	BOTTOM CABINET 104-03971-078	M7	
602	3B	*	A02-2886-08	BOTTOM CABINET 104-03971-078	X9P7T7	
604	2A	*	A60-1617-08	CONTROL PANEL 109-03971-001	E7E9P7	
604	2A	*	A60-1617-08	CONTROL PANEL 109-03971-001	T7M7	
604	2A	*	A60-1618-08	CONTROL PANEL 109-03971-002	E3X3	
604	2A	*	A60-1618-08	CONTROL PANEL 109-03971-002	M4M3P3	
604	2A	*	A60-1619-08	CONTROL PANEL 109-03971-003	T9X9	
605	3B	*	A09-1125-08	BATTERY DOOR 111-03970-071	E3X3	
605	3B	*	A09-1125-08	BATTERY DOOR 111-03970-071	M4M3P3	
605	3B	*	A09-1126-08	BATTERY DOOR 111-03970-078	E7E9T9	
605	3B	*	A09-1126-08	BATTERY DOOR 111-03970-078	M7	
605	3B	*	A09-1126-08	BATTERY DOOR 111-03970-078	X9P7T7	
606	1B	*	A52-0362-08	CD DOOR 113-03970-078		
607	1A	*	A70-1171-05	REMOTE CONTROL (BACK LIGHT)	M4T9X9	
607	1A	*	A70-1171-05	REMOTE CONTROL (BACK LIGHT)	M7E9	
607	1A	*	A70-1190-05	REMOTE CONTROL	E7M3T7	
607	1A	*	A70-1190-05	REMOTE CONTROL	X3	
608	1A	*	A70-1111-08	REMOTE CONTROL	P3E3	
609	2A	*	B10-3472-08	DISPLAY LENS PANEL		
610	1A	*	B10-3473-08	DISPLAY LENS		
611	2A	*	B43-0311-08	KENWOOD BADGE		
-	-	-	B46-0100-50	WARRANTY CARD	E3	
-	-	-	B46-0100-50	WARRANTY CARD	E7E9T9	
-	-	-	B46-0100-50	WARRANTY CARD	X9T7X3	
-	-	-	B46-0336-03	WARRANTY CARD	P3P7	
-	-	-	B60-3105-00	CAR KIT INSTRUCTION	P7	
-	-	-	B60-4034-08	HEADPHONE INST MANUAL(4-LANG)	E9T9X9	
-	-	-	B60-4045-08	INST BOOKLET	P3P7	
-	-	-	B60-4046-08	INST MANUAL(FR)	E3P3	
-	-	-	B60-4046-08	INST MANUAL(FR)	E7E9P7	
-	-	-	B60-4047-08	INST MANUAL(EN)	M4M3T9	
-	-	-	B60-4047-08	INST MANUAL(EN)	X3	
-	-	-	B60-4047-08	INST MANUAL(EN)	X9T7M7	
-	-	-	B60-4048-08	INST MANUAL(SP)	E7M3E9	
-	-	-	B60-4048-08	INST MANUAL(SP)	M7E3	
-	-	-	B60-4049-08	INST MANUAL(TW)	M4M3M7	
-	-	-	B60-4050-08	INST MANUAL(HO)	E7E9E3	
-	-	-	B60-4051-08	INST MANUAL(IT)	E7E9E3	
-	-	-	B60-4052-08	INST MANUAL(GE)	E7E9E3	
-	-	-	B60-4053-08	INST MANUAL(CH)	M4	
615	3A	*	D40-1631-08	CD MECHANISM KSM-620AAA		
619	1A	*	E03-0115-05	AC PLUG ADAPTER	M4M3M7	
620	3B	*	E23-1737-08	BATTERY CONTACT PLATE(-)		

L: Scandinavia K: USA P: Canada R: Mexico C: China I: Malaysia  
 Y: PX(Far East, Hawaii) T: Europe E: Europe G: Germany V: China(Shanghai)  
 Y: AAFES(Europe) X: Australia Q: Russia H: Korea M: Other Areas Δ indicates safety critical components.

\* New Parts

Parts without **Parts No.** are not supplied.Les articles non mentionnés dans le **Parts No.** ne sont pas fournis.Teile ohne **Parts No.** werden nicht geliefert.

②

Ref. No	Add-ress	New Parts	Parts No.	Description	Desti-nation	Re-marks
621	2B	*	E23-1773-08	RECHARGE CONTACT SPRING		
622	3B	*	E23-1783-08	BATTERY CONTACT PLATE(+)		
623	3B	*	E23-1784-08	BATTERY CONTACT SPRING(-)		
624	2A	*	E35-2304-08	24P FILM TYPE CONNECT		
630	3B	*	G13-0562-08	RUBBER FOOT 136-10010-070		
631	2B	*	G01-4108-08	OPEN KNOB SPRING,133-03979-306		
632	2B	*	G01-4109-08	CD DOOR SPRING 162-03971-307		
-	-	*	H25-1603-08	EPE FOAM BAG 150-07009-203		
-	-	*	H25-1649-08	POLY BAG 150-06010-210		
-	-	*	H50-3152-08	ITEM CARTON CASE	P7	
-	-	*	H50-3153-08	ITEM CARTON CASE	M7	
-	-	*	H50-3154-08	ITEM CARTON CASE	E7T7	
-	-	*	H50-3155-08	ITEM CARTON CASE	M3	
-	-	*	H50-3156-08	ITEM CARTON CASE	E9T9X9	
-	-	*	H50-3157-08	ITEM CARTON CASE	X3	
-	-	*	H50-3159-08	ITEM CARTON CASE	P3E3	
-	-	*	H50-3160-08	ITEM CARTON CASE	M4	
635	3A	*	J02-1185-08	CUSHION(MECHA) 161-05847-001		
640	2B	*	K27-2320-08	KNOB SIDE A 127-03936-170	M4M3P3	
640	2B	*	K27-2320-08	KNOB SIDE A 127-03936-170	P7E3X3	
640	2B	*	K27-2346-08	KNOB SIDE A 127-03936-178	E7E9T9	
640	2B	*	K27-2346-08	KNOB SIDE A 127-03936-178	X9T7M7	
641	2B	*	K27-2321-08	KNOB SIDE B 127-03936-270	M4M3P3	
641	2B	*	K27-2347-08	KNOB SIDE B 127-03936-278	P7E3X3	
641	2B	*	K27-2347-08	KNOB SIDE B 127-03936-278	E7E9T9	
642	2A	*	K27-2344-08	KNOB DOOR OPEN 127-03971-070	X9T7M7	
642	2A	*	K27-2344-08	KNOB DOOR OPEN 127-03971-070	M4M3P3	
642	2A	*	K27-2344-08	KNOB DOOR OPEN 127-03971-070	P7E3X3	
642	2A	*	K27-2348-08	KNOB DOOR OPEN 127-03971-078	E7E9T9	
642	2A	*	K27-2348-08	KNOB DOOR OPEN 127-03971-078	X9T7M7	
643	2A	*	K27-2345-08	CD BUTTON SET 128-03972-013		
A	-	*	N09-3363-08	SCREW 2X10 BLK 144-62010-112		
B	-	*	N09-3362-08	SCREW 2X5 BLK 144-52005-112		
C	-	*	N09-3484-08	SCREW 1.7X4 BLK 144-51704-512		
D	-	*	N09-3483-08	SCREW 1.7X3 BLK 144-51703-512		
650	-	*	W01-0923-05	INNER H/P(SHORT)	E3X3P3	
650	1A	*	W01-0923-05	INNER H/P(SHORT)	E7M7T7	
650	1A	*	W01-0923-05	INNER H/P(SHORT)	M3M4	
650	1A	*	W01-0925-05	INNER H/P(LONG)	P7	
651	1A	*	W08-0658-08	AC-DC ADAPTOR 059-96184-202	E7E9E3	
Δ 651	1A	*	W08-0675-08	AC-DC ADAPTOR 059-01814-602	M4M3M7	
Δ 651	1A	*	W08-0677-08	AC-DC ADAPTOR 059-01914-201	P3P7	
Δ 651	1A	*	W08-0678-08	AC-DC ADAPTOR 059-96184-302	T9T7	
Δ 651	1A	*	W08-0679-08	AC-DC ADAPTOR 059-96184-404	X9X3	
652	1A	*	W09-1237-05	RECHARGEABLE BATT,999-00000-022	E9T9X9	
652	1A	*	W09-1239-05	RECHARGEABLE BATT 999-00000-014	P3	
652	1A	*	W09-1240-05	RECHARGEABLE BATT,999-00000-016	E3	
652	1A	*	W09-1240-05	RECHARGEABLE BATT,999-00000-016	E7M4M3	
652	1A	*	W09-1240-05	RECHARGEABLE BATT,999-00000-016	T7M7X3	
653	1A	*	W01-0946-05	HEADPHONE	E9T9X9	
654	1A	*	W01-0922-05	CAR CASSETTE ADAPTER	P7	
655	1A	*	W03-5853-08	CAR BATTERY ADAPTER	P7	

L: Scandinavia K: USA P: Canada R: Mexico C: China I: Malaysia  
 Y: PX(Far East, Hawaii) T: Europe E: Europe G: Germany V: China(Shanghai)  
 Y: AAFES(Europe) X: Australia Q: Russia H: Korea M: Other Areas Δ indicates safety critical components.

\* New Parts

Parts without **Parts No.** are not supplied.  
Les articles non mentionnés dans le **Parts No.** ne sont pas fournis.  
Teile ohne **Parts No.** werden nicht geliefert.

③

Ref. No	Add-ress	New Parts	Parts No.	Description	Desti-nation	Re-marks
<b>ELECTRONICS PARTS</b>						
LC101		*	B38-0175-08	LCD DISPLAY ASSY		
C1			CE04CW0J101M	ELECTRO 100UF 6.3WV		
C2A, 3A			CK73FB1E104K	CHIP C 0.10UF K		
C5A			CK73FB1H105Z	CHIP C 1.0UF Z		
C6A			CK73FB1E104K	CHIP C 0.10UF K		
C8			CE04CW1H4R7M	ELECTRO 4.7UF 50WV		
C9			CE04CW1C220M	ELECTRO 22UF 16WV		
C11A			CK73FB1E223K	CHIP C 0.022UF K		
C103A, 104A			CK73FB1E223K	CHIP C 0.022UF K		
C106A			CC73FSL1H470J	CHIP C 47PF J		
C107A			CC73FSL1H020C	CHIP C 2.0PF C		
C111A			CK73FB1E104K	CHIP C 0.10UF K		
C112A			CK73FB1E223K	CHIP C 0.022UF K		
C113A, 114A			CK73FB1E273K	CHIP C 0.027UF K		
C115A			CC73FSL1H151J	CHIP C 150PF J		
C116A			CK73FB1H471K	CHIP C 470PF K		
C117			CE04CW0J101M	ELECTRO 100UF 6.3WV		
C118A			CK73FB1H105Z	CHIP C 1.0UF Z		
C120A			CK73FB1H105Z	CHIP C 1.0UF Z		
C121A-124A			CK73FB1E104K	CHIP C 0.10UF K		
C125A, 126A			CK73FB1H102K	CHIP C 1000PF K		
C127A			CK73FB1H152K	CHIP C 1500PF K		
C128A			CK73FB1H105Z	CHIP C 1.0UF Z		
C129			CE04CW1H010M	ELECTRO 1.0UF 50WV		
C130A, 131A			CK73FB1H102K	CHIP C 1000PF K		
C132A			CK73FB1E104K	CHIP C 0.10UF K		
C133			CE04CW1C101M	ELECTRO 100UF 16WV		
C134A			CC73FSL1H331J	CHIP C 330PF J		
C135A			CK73FB1E104K	CHIP C 0.10UF K		
C136			CE04CW1H4R7M	ELECTRO 4.7UF 50WV		
C137A			CK73FB1E104K	CHIP C 0.10UF K		
C138			CE04CW0J101M	ELECTRO 100UF 6.3WV		
C139A			CK73FB1H102K	CHIP C 1000PF K		
C140A			CK73FB1E223K	CHIP C 0.022UF K		
C141A-143A			CK73FB1H102K	CHIP C 1000PF K		
C144, 145			CE04CW0J221M	ELECTRO 220UF 6.3WV		
C146			CK45FB1H103Z	CERAMIC 0.010UF Z		
C147A			CK73FB1H105Z	CHIP C 1.0UF Z		
C148			CC45FSL1H470J	CERAMIC 47PF J		
C150			CE04CW1C101M	ELECTRO 100UF 16WV		
C151			CE04CW0J101M	ELECTRO 100UF 6.3WV		
C152			CE04CW1A470M	ELECTRO 47UF 10WV		
C153			CE04CW0J101M	ELECTRO 100UF 6.3WV		
C153A			CC73FSL1H221J	CHIP C 220PF J		
C161A			CK73FB1H102K	CHIP C 1000PF K		
C162A			CK73FB1H105Z	CHIP C 1.0UF Z		
C163A			CK73FB1E223K	CHIP C 0.022UF K		
C164A			CK73FB1H224Z	CHIP C 0.22UF Z		
C166			CE04CW0J221M	ELECTRO 220UF 6.3WV		
C167A			CC73FSL1H200J	CHIP C 20PF J		
C168A			CC73FSL1H390J	CHIP C 39PF J		
C169A			CK73FB1H105Z	CHIP C 1.0UF Z		

L : Scandinavia K : USA P : Canada R : Mexico C : China I : Malaysia  
Y : PX(Far East, Hawaii) T : Europe E : Europe G : Germany V : China(Shanghai)  
Y : AAFES(Europe) X : Australia Q : Russia H : Korea M : Other Areas Δ indicates safety critical components.

\* New Parts

Parts without **Parts No.** are not supplied.  
Les articles non mentionnés dans le **Parts No.** ne sont pas fournis.  
Teile ohne **Parts No.** werden nicht geliefert.

④

Ref. No	Add-ress	New Parts	Parts No.	Description	Desti-nation	Re-marks
C171			CE04CW0J101M	ELECTRO 100UF 6.3WV		
C172A			CK73FB1H105Z	CHIP C 1.0UF Z		
C177A			CK73FB1H105Z	CHIP C 1.0UF Z		
C180A			CK73FB1H105Z	CHIP C 1.0UF Z		
C182A			CK73FB1H105Z	CHIP C 1.0UF Z		
C183A			CK73FB1H102K	CHIP C 1000PF K		
C184			CE04CW1A471M	ELECTRO 470UF 10WV		
C185			CE04CW1A470M	ELECTRO 47UF 10WV		
C201			CK45FB1H272K	CERAMIC 2700PF K		
C202			CK45FB1H301J	CERAMIC 300PF J		
C203, 204			CE04CW1H4R7M	ELECTRO 4.7UF 50WV		
C205			CK73FB1H223K	CHIP C 0.022UF K		
C206			CE04CW0J221M	ELECTRO 220UF 6.3WV		
C207A			CK73FB1H224Z	CHIP C 0.22UF Z		
C220			CE04CW1A470M	ELECTRO 47UF 10WV		
C221			CK45FB1H102K	CERAMIC 1000PF K	X9X3	
C301			CK45FB1H272K	CERAMIC 2700PF K		
C302			CK45FB1H301J	CERAMIC 300PF J		
C303, 304			CE04CW1H4R7M	ELECTRO 4.7UF 50WV		
C305			CK73FB1H223K	CHIP C 0.022UF K		
C306			CE04CW0J221M	ELECTRO 220UF 6.3WV		
C307A			CK73FB1H224Z	CHIP C 0.22UF Z		
C320			CE04CW1A470M	ELECTRO 47UF 10WV		
C321			CK45FB1H102K	CERAMIC 1000PF K	X9X3	
C322			CE04KW1H4R7M	ELECTRO 4.7UF 50WV		
C502A			CK73FB1H105Z	CHIP C 1.0UF Z		
CN1		*	E60-0006-08	FILM CONNECTOR(MAIN PCB)		
CN1		*	E60-0007-08	FILM CONNECTOR(DISPLAY PCB)		
CN4		*	E60-0008-08	FILM CONNECTOR(PICKUP)		
J101			E03-0356-08	DC JACK 021-34505-100		
J102			E11-0372-08	PHONE JACK,3.6MM GREEN		
J103			E11-0355-08	STEREO PHONE JACK		
J105			E11-0354-08	STEREO PHONE JACK 021-23605-1	X9X3	
L102			L33-0585-08	CHOKE COIL 1MH		
L105			L33-0564-08	CHOKE COIL 33UH		
L106			L33-0565-08	CHOKE COIL 95UH		
X1		*	L77-2240-08	CRYSTAL RESONATOR 16.9344MHZ		
JP11A			RK73FB2A000J	CHIP R 0 J 1/10W	E7E9T9	
JP11A			RK73FB2A000J	CHIP R 0 J 1/10W	M7	
JP11A			RK73FB2A000J	CHIP R 0 J 1/10W	X9P7T7	
JP13A			RK73FB2A000J	CHIP R 0 J 1/10W	E7E9T9	
JP13A			RK73FB2A000J	CHIP R 0 J 1/10W	M7	
JP13A			RK73FB2A000J	CHIP R 0 J 1/10W	X9P7T7	
JP15A			RK73FB2A000J	CHIP R 0 J 1/10W	E7M4M3	
JP15A			RK73FB2A000J	CHIP R 0 J 1/10W	E9T9X9	
JP15A			RK73FB2A000J	CHIP R 0 J 1/10W	P7T7M7	
JP15A			RK73FB2A000J	CHIP R 0 J 1/10W	X3	
R1A-3A			RK73FB2A103J	CHIP R 10K J 1/10W		
R7A, 8A			RK73FB2A473J	CHIP R 47K J 1/10W		
R21A			RK73FB2A102J	CHIP R 1.0K J 1/10W		
R22A			RK73FB2A472J	CHIP R 4.7K J 1/10W		
R23A			RK73FB2A563J	CHIP R 56K J 1/10W		
R29A			RK73FB2A682J	CHIP R 6.8K J 1/10W		

L : Scandinavia K : USA P : Canada R : Mexico C : China I : Malaysia  
Y : PX(Far East, Hawaii) T : Europe E : Europe G : Germany V : China(Shanghai)  
Y : AAFES(Europe) X : Australia Q : Russia H : Korea M : Other Areas Δ indicates safety critical components.

PARTS LIST

DPC-397/797/997

\* New Parts  
 Parts without **Parts No.** are not supplied.  
 Les articles non mentionnés dans le **Parts No.** ne sont pas fournis.  
 Teile ohne **Parts No.** werden nicht geliefert.



Ref. No	Add-ress	New Parts	Parts No.	Description	Desti-nation	Re-marks
R30A			RK73FB2A331J	CHIP R 330	J 1/10W	
R31A			RK73FB2A122J	CHIP R 1.2K	J 1/10W	
R32A			RK73FB2A152J	CHIP R 1.5K	J 1/10W	
R33A			RK73FB2A182J	CHIP R 1.8K	J 1/10W	
R34A			RK73FB2A242J	CHIP R 2.4K	J 1/10W	
R35A			RK73FB2A362J	CHIP R 3.6K	J 1/10W	
R38A			RK73FB2A101J	CHIP R 100	J 1/10W	
R40A			RK73FB2A100J	CHIP R 10	J 1/10W	
R41A, 42A			RK73FB2A472J	CHIP R 4.7K	J 1/10W	
R43A			RK73FB2A103J	CHIP R 10K	J 1/10W	
R46A, 47A			RK73FB2A100J	CHIP R 10	J 1/10W	
R48A			RK73FB2A472J	CHIP R 4.7K	J 1/10W	
R49A			RK73FB2A100J	CHIP R 10	J 1/10W	
R50A			RK73FB2A103J	CHIP R 10K	J 1/10W	M4E9T9
R50A			RK73FB2A103J	CHIP R 10K	J 1/10W	X9P7M7
R51A			RK73FB2A122J	CHIP R 1.2K	J 1/10W	P3E3
R52A			RK73FB2A152J	CHIP R 1.5K	J 1/10W	P3E3
R54A			RK73FB2A223J	CHIP R 22K	J 1/10W	
R55A			RK73FB2A103J	CHIP R 10K	J 1/10W	
R56A			RK73FB2A223J	CHIP R 22K	J 1/10W	
R57A			RK73FB2A153J	CHIP R 15K	J 1/10W	
R58A			RK73FB2A103J	CHIP R 10K	J 1/10W	
R59A			RK73FB2A333J	CHIP R 33K	J 1/10W	
R61A			RK73FB2A333J	CHIP R 33K	J 1/10W	
R66A			RK73FB2A103J	CHIP R 10K	J 1/10W	
R68A			RK73FB2A473J	CHIP R 47K	J 1/10W	
R69A			RK73FB2A104J	CHIP R 100K	J 1/10W	
R74A			RK73FB2A682J	CHIP R 6.8K	J 1/10W	
R75A			RK73FB2A103J	CHIP R 10K	J 1/10W	E7M4M3
R75A			RK73FB2A103J	CHIP R 10K	J 1/10W	E9T9X9
R75A			RK73FB2A103J	CHIP R 10K	J 1/10W	P7T7M7
R75A			RK73FB2A103J	CHIP R 10K	J 1/10W	X3
R76A			RK73FB2A332J	CHIP R 3.3K	J 1/10W	E7M4M3
R76A			RK73FB2A332J	CHIP R 3.3K	J 1/10W	E9T9X9
R76A			RK73FB2A332J	CHIP R 3.3K	J 1/10W	P7T7M7
R76A			RK73FB2A332J	CHIP R 3.3K	J 1/10W	X3
R77A			RK73FB2A223J	CHIP R 22K	J 1/10W	M4E9T9
R77A			RK73FB2A223J	CHIP R 22K	J 1/10W	X9P7M7
R78A			RK73FB2A473J	CHIP R 47K	J 1/10W	M4E9T9
R78A			RK73FB2A473J	CHIP R 47K	J 1/10W	X9P7M7
R83A			RK73FB2A102J	CHIP R 1.0K	J 1/10W	
R84A			RK73FB2A4R7J	CHIP R 4.7	J 1/10W	
R85A			RK73FB2A3R9J	CHIP R 3.9	J 1/10W	
R86A			RK73FB2A102J	CHIP R 1.0K	J 1/10W	
R87A-89A			RK73FB2A103J	CHIP R 10K	J 1/10W	
R99A, 100A			RK73FB2A103J	CHIP R 10K	J 1/10W	
R109A			RK73FB2A124J	CHIP R 120K	J 1/10W	
R110A			RK73FB2A333J	CHIP R 33K	J 1/10W	
R111A			RK73FB2A104J	CHIP R 100K	J 1/10W	
R112A			RK73FB2A154J	CHIP R 150K	J 1/10W	
R113A			RK73FB2A472J	CHIP R 4.7K	J 1/10W	
R114A			RK73FB2A682J	CHIP R 6.8K	J 1/10W	
R115A			RK73FB2A332J	CHIP R 3.3K	J 1/10W	
R116A			RK73FB2A153J	CHIP R 15K	J 1/10W	
R119A			RK73FB2A393J	CHIP R 39K	J 1/10W	

L : Scandinavia    K : USA    P : Canada    R : Mexico    C : China    I : Malaysia  
 Y : PX(Far East, Hawaii)    T : Europe    E : Europe    G : Germany    V : China(Shanghai)  
 Y : AAFES(Europe)    X : Australia    Q : Russia    H : Korea    M : Other Areas    Δ indicates safety critical components.

\* New Parts  
 Parts without **Parts No.** are not supplied.  
 Les articles non mentionnés dans le **Parts No.** ne sont pas fournis.  
 Teile ohne **Parts No.** werden nicht geliefert.



Ref. No	Add-ress	New Parts	Parts No.	Description	Desti-nation	Re-marks
R120A			RK73FB2A183J	CHIP R 18K	J 1/10W	
R121A			RK73FB2A000J	CHIP R 0	J 1/10W	
R122A			RK73FB2A333J	CHIP R 33K	J 1/10W	
R123A			RK73FB2A472J	CHIP R 4.7K	J 1/10W	
R124A			RK73FB2A223J	CHIP R 22K	J 1/10W	
R125A			RK73FB2A153J	CHIP R 15K	J 1/10W	
R126A			RK73FB2A470J	CHIP R 47	J 1/10W	
R134A			RK73FB2A101J	CHIP R 100	J 1/10W	
R136A			RK73FB2A4R7J	CHIP R 4.7	J 1/10W	
R137A			RK73FB2A152J	CHIP R 1.5K	J 1/10W	
R138A			RK73FB2A100J	CHIP R 10	J 1/10W	
R139A			RK73FB2A331J	CHIP R 330	J 1/10W	
R140A			RK73FB2A474J	CHIP R 470K	J 1/10W	
R166A			RK73FB2A102J	CHIP R 1.0K	J 1/10W	
R168A			RK73FB2A273J	CHIP R 27K	J 1/10W	
R169A			RK73FB2A333J	CHIP R 33K	J 1/10W	
R170A			RK73FB2A562J	CHIP R 5.6K	J 1/10W	
R171A			RK73FB2A104J	CHIP R 100K	J 1/10W	
R174A			RK73FB2A682J	CHIP R 6.8K	J 1/10W	
R175A			RK73FB2A122J	CHIP R 1.2K	J 1/10W	
R177A			RK73FB2A683J	CHIP R 68K	J 1/10W	
R178A			RK73FB2A184J	CHIP R 180K	J 1/10W	
R179A			RK73FB2A821J	CHIP R 820	J 1/10W	
R180A			RK73FB2A473J	CHIP R 47K	J 1/10W	
R182A			RK73FB2A222J	CHIP R 2.2K	J 1/10W	
R183A			RK73FB2A470J	CHIP R 47	J 1/10W	
R184A			RK73FB2A473J	CHIP R 47K	J 1/10W	
R201A			RK73FB2A102J	CHIP R 1.0K	J 1/10W	
R202A			RK73FB2A473J	CHIP R 47K	J 1/10W	
R203A			RK73FB2A104J	CHIP R 100K	J 1/10W	
R204A			RK73FB2A471J	CHIP R 470	J 1/10W	
R206A			RK73FB2A153J	CHIP R 15K	J 1/10W	
R207A			RK73FB2A564J	CHIP R 560K	J 1/10W	
R209A			RK73FB2A100J	CHIP R 10	J 1/10W	
R210A			RK73FB2A101J	CHIP R 100	J 1/10W	
R211A			RK73FB2A681J	CHIP R 680	J 1/10W	
R220A			RK73FB2A302J	CHIP R 3.0K	J 1/10W	
R221A			RK73FB2A471J	CHIP R 470	J 1/10W	X9X3
R222A			RK73FB2A472J	CHIP R 4.7K	J 1/10W	
R301A			RK73FB2A102J	CHIP R 1.0K	J 1/10W	
R302A			RK73FB2A473J	CHIP R 47K	J 1/10W	
R303A			RK73FB2A104J	CHIP R 100K	J 1/10W	
R304A			RK73FB2A471J	CHIP R 470	J 1/10W	
R306A			RK73FB2A153J	CHIP R 15K	J 1/10W	
R307A			RK73FB2A564J	CHIP R 560K	J 1/10W	
R309A			RK73FB2A100J	CHIP R 10	J 1/10W	
R310A			RK73FB2A101J	CHIP R 100	J 1/10W	
R311A			RK73FB2A681J	CHIP R 680	J 1/10W	
R320A			RK73FB2A302J	CHIP R 3.0K	J 1/10W	
R321A			RK73FB2A471J	CHIP R 470	J 1/10W	X9X3
R322A			RK73FB2A472J	CHIP R 4.7K	J 1/10W	
R501A, 502A			RK73FB2A333J	CHIP R 33K	J 1/10W	
R504A			RK73FB2A184J	CHIP R 180K	J 1/10W	
R505A			RK73FB2A472J	CHIP R 4.7K	J 1/10W	
VR101			R31-0086-08	VARIABLE RESISTOR		

L : Scandinavia    K : USA    P : Canada    R : Mexico    C : China    I : Malaysia  
 Y : PX(Far East, Hawaii)    T : Europe    E : Europe    G : Germany    V : China(Shanghai)  
 Y : AAFES(Europe)    X : Australia    Q : Russia    H : Korea    M : Other Areas    Δ indicates safety critical components.

\* New Parts

Parts without **Parts No.** are not supplied.  
Les articles non mentionnés dans le **Parts No.** ne sont pas fournis.  
Teile ohne **Parts No.** werden nicht geliefert.

7

Ref. No	Add-ress	New Parts	Parts No.	Description	Desti-nation	Re-marks
SW101~106		*	S70-0070-08	TACT SWITCH 020-31100-161		
SW107			S62-0082-08	SLIDE SWITCH 020-21203-147		
SW108			S62-0064-08	SLIDE SWITCH 020-11203-103	M4M3P3	
SW108			S62-0064-08	SLIDE SWITCH 020-11203-103	X3E3	
SW108		*	S62-0085-08	SLIDE SWITCH 020-21303-147	E7E9T9	
SW108		*	S62-0085-08	SLIDE SWITCH 020-21303-147	M7	
SW108		*	S62-0085-08	SLIDE SWITCH 020-21303-147	X9P7T7	
SW109		*	S74-0082-08	MICRO SWITCH 020-31100-053		
D5			UDZ6.8B	ZENER DIODE		
D6A~8A			1SS355	DIODE		
D104			SB10-03A3-BT	DIODE		
D105A			1SS355	DIODE		
D111, 112			IN-4001	DIODE		
D115, 116			GMB01-BT	DIODE		
D117, 118			GMB01-BT	DIODE		
D119, 120			SB10-03A3-BT	DIODE	M4E9T9	
D119, 120			SB10-03A3-BT	DIODE	X9P7M7	
D122A			1SS355	DIODE		
D201			GMB01-BT	DIODE		
D301			GMB01-BT	DIODE		
IC1			AN8838SB	IC(CD DIGITAL SERVO)		
IC2			BH6509K	IC		
IC3			MN101C167	IC		
IC4			MN662746RPK1	IC		
IC5			SM5859AF	IC(PROOF MEMORY)	M4M3P3	
IC5			SM5859AF	IC(PROOF MEMORY)	X3E3	
IC5			SM5902AF	IC(PROOF MEMORY)	E7E9T9	
IC5			SM5902AF	IC(PROOF MEMORY)	M7	
IC5			SM5902AF	IC(PROOF MEMORY)	X9P7T7	
IC6			MN41V17400CTT6	IC	E7E9T9	
IC6			MN41V17400CTT6	IC	M7	
IC6			MN41V17400CTT6	IC	X9P7T7	
IC7			MN41V4400SJ-08	IC	M4M3P3	
IC7			MN41V4400SJ-08	IC	X3E3	
IC9			NJM2073M	IC(AF POWER AMP)		
IC10			AN8086S	IC		
Q4			2SC3330	TRANSISTOR		
Q5			2SA1317	TRANSISTOR		
Q6			2SC3330	TRANSISTOR		
Q104			2SA1317	TRANSISTOR		
Q105			2SC4048-AC	TRANSISTOR		
Q106			2SC4481T	TRANSISTOR		
Q107			2SD734F	TRANSISTOR		
Q108			2SD1805F	TRANSISTOR		
Q108			2SD1805G	TRANSISTOR		
Q110			2SA1317	TRANSISTOR		
Q111, 112			2SB926T	TRANSISTOR		
Q113			2SA1317	TRANSISTOR	E7M4M3	
Q113			2SA1317	TRANSISTOR	T7M7	
Q113			2SA1317	TRANSISTOR	T9X9P7	
Q114			2SA1317	TRANSISTOR	M4E9P7	
Q114			2SA1317	TRANSISTOR	T9X9M7	
Q116			2SA1564-AC	TRANSISTOR		
Q117~120			2SC3330	TRANSISTOR		

L : Scandinavia K : USA P : Canada R : Mexico C : China I : Malaysia  
Y : PX(Far East, Hawaii) T : Europe E : Europe G : Germany V : China(Shanghai)  
Y : AAFES(Europe) X : Australia Q : Russia H : Korea M : Other Areas  $\Delta$  indicates safety critical components.

\* New Parts

Parts without **Parts No.** are not supplied.  
Les articles non mentionnés dans le **Parts No.** ne sont pas fournis.  
Teile ohne **Parts No.** werden nicht geliefert.

8

Ref. No	Add-ress	New Parts	Parts No.	Description	Desti-nation	Re-marks
Q201			2SC3330	TRANSISTOR		
Q202			2SD734F	TRANSISTOR	X9X3	
Q203			2SC3860	TRANSISTOR		
Q205			2SC3860	TRANSISTOR		
Q301			2SC3330	TRANSISTOR		
Q302			2SD734F	TRANSISTOR	X9X3	
Q303			2SC3860	TRANSISTOR		
Q304			2SC3330	TRANSISTOR		
Q305			2SC3860	TRANSISTOR		
J104			W02-2630-08	OPTICAL JACK 021-43607-100		

L : Scandinavia K : USA P : Canada R : Mexico C : China I : Malaysia  
Y : PX(Far East, Hawaii) T : Europe E : Europe G : Germany V : China(Shanghai)  
Y : AAFES(Europe) X : Australia Q : Russia H : Korea M : Other Areas  $\Delta$  indicates safety critical components.

**HOW TO READ THE PARTS LIST**

**ABBREVIATION OF MODEL AND MASS PRODUCTION'S DESTINATIONS**

MODEL	ABB.	Australia	Canada	China	England	Europe	Germany	Korea	Malaysia
DPC-397	3	X3	P3	-	-	E3	-	-	-
DPC-797	7	-	P7	-	T7	E7	-	-	-
DPC-997	9	X9	-	-	T9	E9	-	-	-
MODEL	ABB.	Mexico	PX/AAFES	Russia	Scandinavia	Shanghai	USA	Other area	Other area(M2)
DPC-397	3,4	-	-	-	-	-	-	M3	M4
DPC-797	7	-	-	-	-	-	-	M7	-
DPC-997	9	-	-	-	-	-	-	-	-

PARTS LIST

DPC-397/797/997

# DPC-397/797/997

**Note:**

Component and circuit are subject to modification to insure best operation under differing local conditions. This manual is based on Europe (E) standard, and provides information on regional circuit modification through use of alternate schematic diagrams, and information on regional component variations through use of parts list.

## **KENWOOD CORPORATION**

14-6,Dogenzaka 1-chome, Shibuya-ku, Tokyo, 150-8501 Japan

### **KENWOOD SERVICE CORPORATION**

P.O BOX 22745, 2201 East Dominguez St., Long Beach, CA 90801-5745, U.S.A.

### **KENWOOD ELECTRONICS CANADA INC.**

6070 Kestrel Road, Mississauga, Ontario, Canada L5T 1S8

### **KENWOOD ELECTRONICS LATIN AMERICA S.A.**

P.O BOX 55-2791, Piso 6 plaza Chase, Cl. 47 y Aquilino de la Guardia Panama, Republic de Panama

### **KENWOOD ELECTRONICS BRASIL LTDA.**

Av Indianópolis, 628, 04062-001 Planalto Paullista São Paulo-SP-Brasil

### **KENWOOD ELECTRONICS U.K. LIMITED**

KENWOOD House, Dwight Road, Watford, Herts., WD1 8EB., United Kingdom

### **KENWOOD ELECTRONICS BELGUM N.V.**

Meachelsesteenweg 418, B-1930 Zaventem, Belgium

### **KENWOOD ELECTRONICS DEUTSCHLAND GMBH**

Rembrücker Str. 15, 63150 Heusenstamm, Germany

### **KENWOOD ELECTRONICS FRANCE S.A.**

13 Boulevard Ney, 75018 Paris, France

### **KENWOOD ELECTRONICS ITALIA S.p.A.**

Via G. Sirtori, 7/9 20129, Milano, Italy

### **KENWOOD IBÉRICA S.A.**

Bolivia, 239-08020 Barcelona, Spain

### **KENWOOD ELECTRONICS AUSTRALIA PTY. LTD.**

(A.C.N. 001499 074)

P.O Box 504, 8 Figtree Drive, Australia Centre, Homebush, N.S.W. 2140, Australia

### **KENWOOD & LEE ELECTRONICS, LTD.**

Unit 3712-3724, Level 37, Tower 1, Metroplaza, 223 Hing Fong Road, Kwai Fong N.T., Hong Kong

### **KENWOOD ELECTRONICS GULF FZE**

P.O.Box 61318, Jebel Ali, Dubai, U.A.E.

### **KENWOOD ELECTRONICS SINGAPORE PTE LTD.**

No. 1 Genting Lane #02-02, KENWOOD Building, Singapore, 349544

### **KENWOOD ELECTRONICS (MALAYSIA) SDN BHD.**

#4.01 Level 4, Wisma Academy Lot 4A, Jalan 19/1 46300 Petaling Jaya Selangor Darul Ehsan Malaysia

### **KENWOOD ELECTRONICS (THAILAND) CO., LTD.**

573/111 Soi Ramkhamhaeng 39, Ramkhamhaeng Road, Wangthonglang, Bangkok, Bangkok 10301 Thailand